

30 03 500, Motorschaltschrank Tanner MDC 100/200/300, 230V

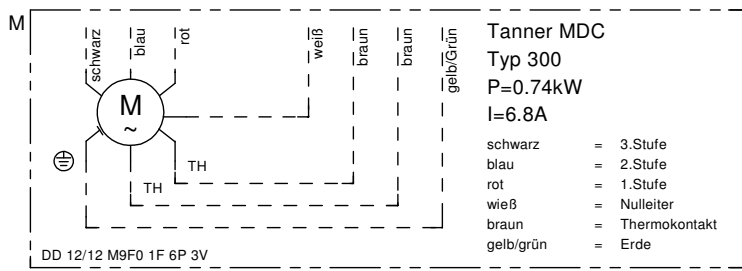
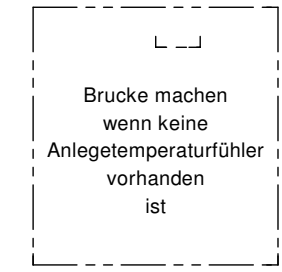
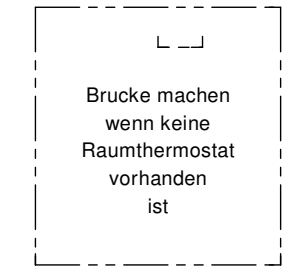
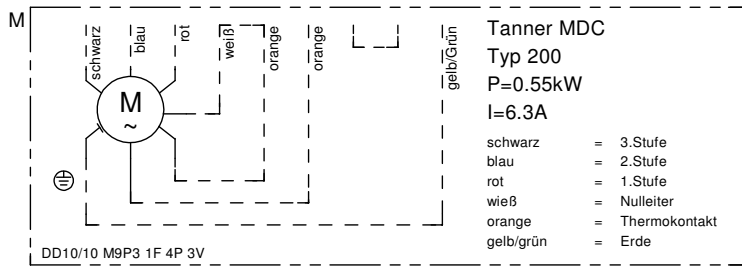
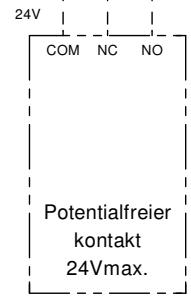
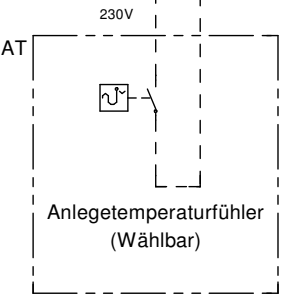
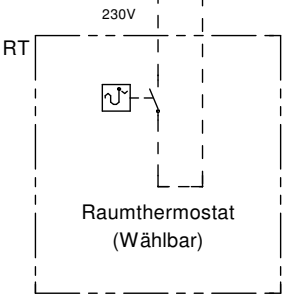
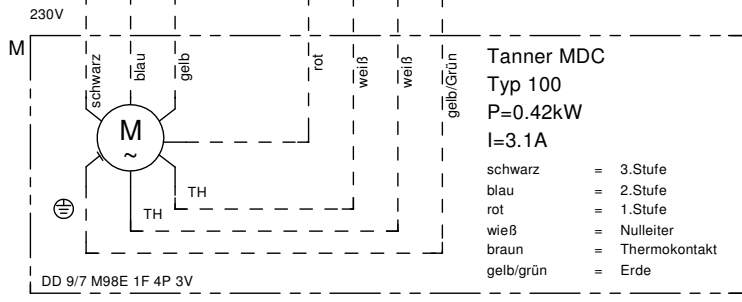
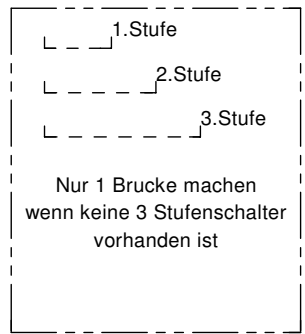
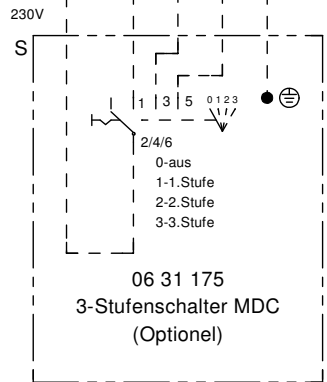
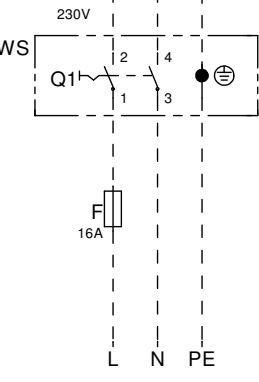
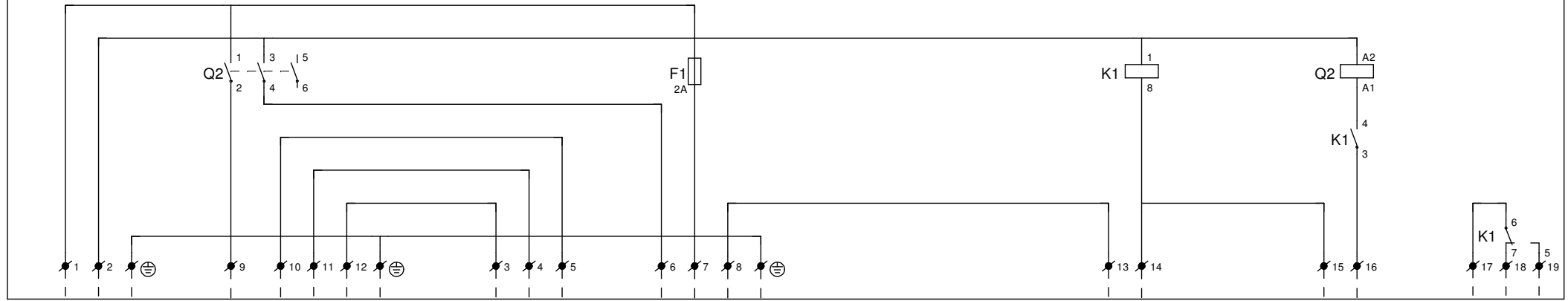

WS - 06 31 162 Reparaturschalter